

19" DYNAMIC Basic Free Standing Cabinets

Width: 600 mm.
Depth: 800 mm.

Width=600mm
Depth=800mm

Standard Heights:

4 different U heights: 22U, 26U
32U, 42U

Standards, and Compliances:



ISO 9001:2008
Quality Management System

EN 61587 -1:2012
Mechanical Structures for
Electronic Equipment

IEC 297-1, 19" mounting
IEC 297-2 Overall cabinet dimensions



CE conform to
EN 60950-1:2006
Information Technology
Equipment – Safety – Part-1-
General Requirements



Environment Friendly;
*ISO 14001 Environmental
Management System
*Environmental awareness
*RoHS compliancy
*% 100 Recyclable Material.

Load Capacity: 600 kgs.



DYNAMIC series Networking Enclosures, with 19" w:600mm and d:800mm physical sizes, with max internal usable depth and 4 different height, gives a wide selection chart for users.

Standard Colors:

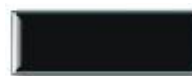

RAL 9005 Black

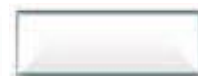

RAL 7035 Light Grey

19" DYNAMIC Basic Cabinets

W:600mm D:800mm Drawings

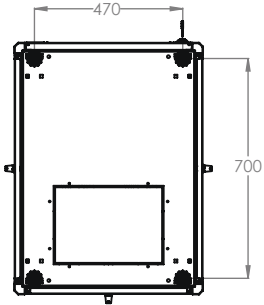

BOTTOM VIEW

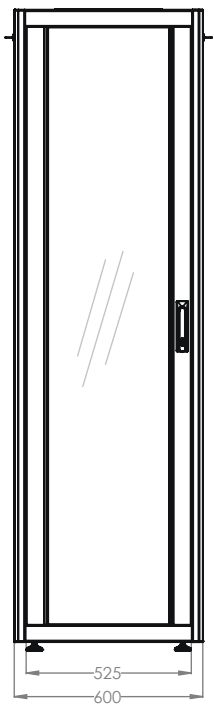

FRONT VIEW

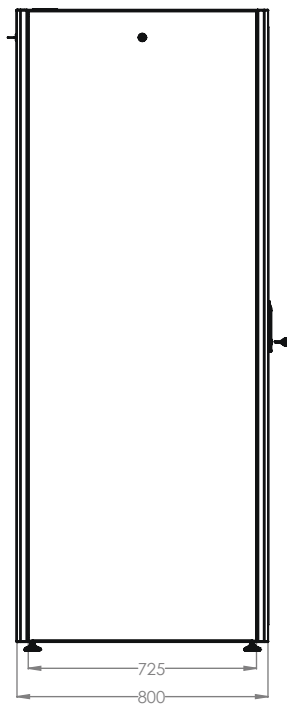

SIDE VIEW

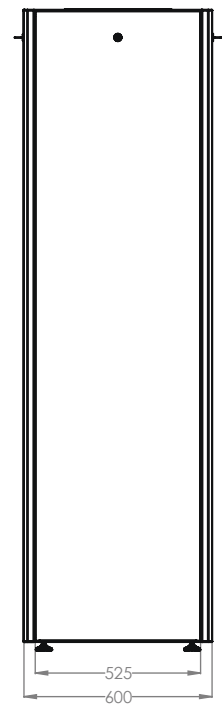

REAR VIEW

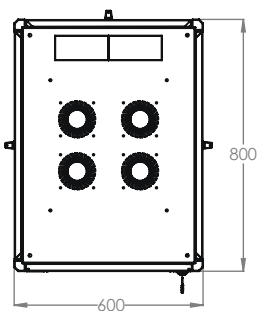

TOP VIEW

19" DYNAmic Basic Cabinets

W:600mm D:800mm Drawings

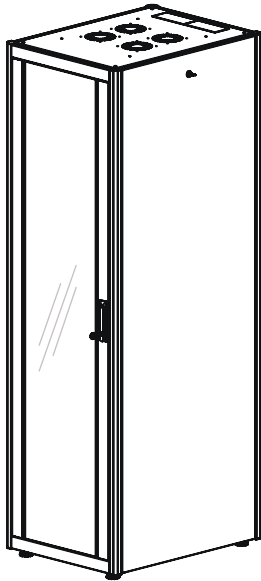

ISOMETRIC VIEW

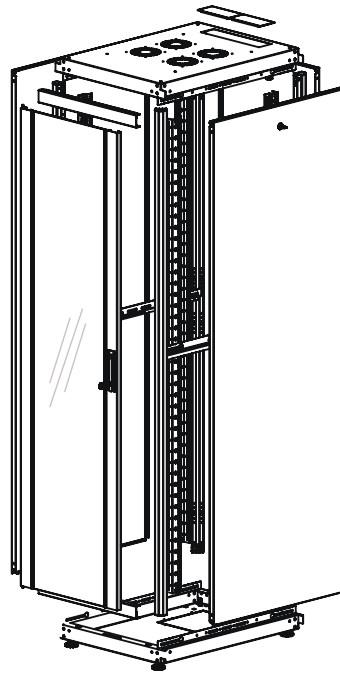

EXPLODED VIEW

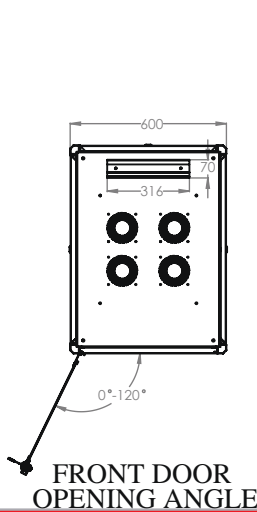

FRONT DOOR
OPENING ANGLE

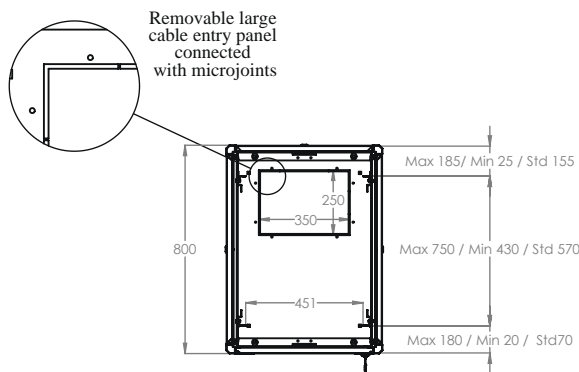

MAX / STD / MIN
EQUIPMENT
MOUNTING DISTANCE

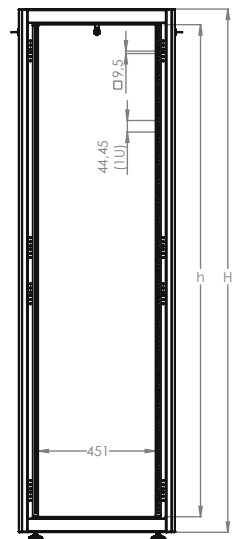

DIMENSIONS
IN
WIDTH AND HEIGHT

DYNAmic Basic Series Free Standing 19" Cabinets W=600mm D=800mm

ROOT Product Number ***	Product Description	Size WxDxH mm	HU size (U)	HU in mm	*H mm, overall without feet and/or castor	Width Overall mm	Width Rail to Rail mm	Depth Overall mm	**Depth Shipping Conf. Rail to Rail mm	QTY IN PACKAGE	ASSEMBLED PACKAGE DIMENSIONS WxDxH	Standard NET Weight of product kgs	Gross Weight of Products kgs
LN-DB22U6080-CC	22U 19" Free Standing Cabinet W=600mm D=800mm	600x800x1125	22U	978	1125	600	19"	800	570	1	680x880x1265	43	52
LN-DB26U6080-CC	26U 19" Free Standing Cabinet W=600mm D=800mm	600x800x1300	26U	1155	1300	600	19"	800	570	1	680x880x1440	51	60
LN-DB32U6080-CC	32U 19" Free Standing Cabinet W=600mm D=800mm	600x800x1560	32U	1422	1560	600	19"	800	570	1	680x880x1700	63	72
LN-DB42U6080-CC	42U 19" Free Standing Cabinet W=600mm D=800mm	600x800x2010	42U	1867	2010	600	19"	800	570	1	680x880x2150	82	93

* Please add 30mm to H mm once used with Leveling Feet, add 80mm to H mm once used with castor set. ** See min and max Adjustable depth variations on drawings.

*** CC= LG for Light Grey RAL 7035 & BL for Black RAL 9005 for customers to define while ordering.

**** Unless defined delivery is in Flat Pack, Please add A notation to The Part number for assembled delivery ie. LN-DB22U6080-CC-A

***** The Logistical information provided in above chart is based on assembled product since packing details of flat-pack is changing based on transport vehicle and the delivery location. Please consider delivery notes, packing lists and recent data provided with the logistics services of Lande.